

www.xcmg.com

# XGC180E履带起重机

## XGC180E CRAWLER CRANE

### 徐工集团工程机械股份有限公司

XCMG CONSTRUCTION MACHINERY CO.,LTD.

地址(Add): 中国江苏省徐州市金山桥经济开发区桃山路19号 邮编(Post Code): 221001  
No.19 Taoshan Road, Economic development zone of jinshanqiao,Xuzhou,Jiangsu Province,China  
销售电话(Sale Tel): 86 0516-87892099 销售传真(Sale Fax): 86 0516-87892015  
服务电话(Service Tel): 86 0516-87892088 服务传真(Service Fax): 86 0516-87892080  
备件电话(Service Tel): 86 0516-87892086 备件传真(Service Fax): 86 0516-87892083  
服务质量投诉电话(Quality Supervision Tel): 86 0516-87892587  
统一服务热线(Unified service hotline): 86 400-110-9999

请垂询

CONTACT

# XGC180E履带起重机

# XGC180E CRAWLER CRANE



 徐工集团工程机械股份有限公司

XCMG CONSTRUCTION MACHINERY CO.,LTD.

# 技术性能参数/整机基本尺寸 Technical Specification/Overall Dimension

# 主要零部件 Main Parts

## 目录 CONTENTS

技术性能参数/整机基本尺寸  
Technical Specification/Overall Dimension

主要零部件  
Main Parts

详细介绍  
Detailed Introduction

自拆装(选配)  
Self Assembly/Disassembly (Optional Function)

主臂工况节组合  
Boom Combination

主臂工作范围  
Boom Working Area

主臂工况载荷表  
Boom Working Condition And Lifting Load Chart

臂头单滑轮载荷表  
Boom single top lifting load chart

固定副臂节组合  
Fixed Jib Combinations

固定副臂作业范围  
Fixed Jib Working Area

固定副臂工况载荷表  
Fixed jib lifting load chart

变幅副臂节组合  
Luffing Jib Combination





变幅副臂工作范围图  
Luffing Jib Working Area

变幅副臂工况载荷表  
Luffing jib lifting load chart

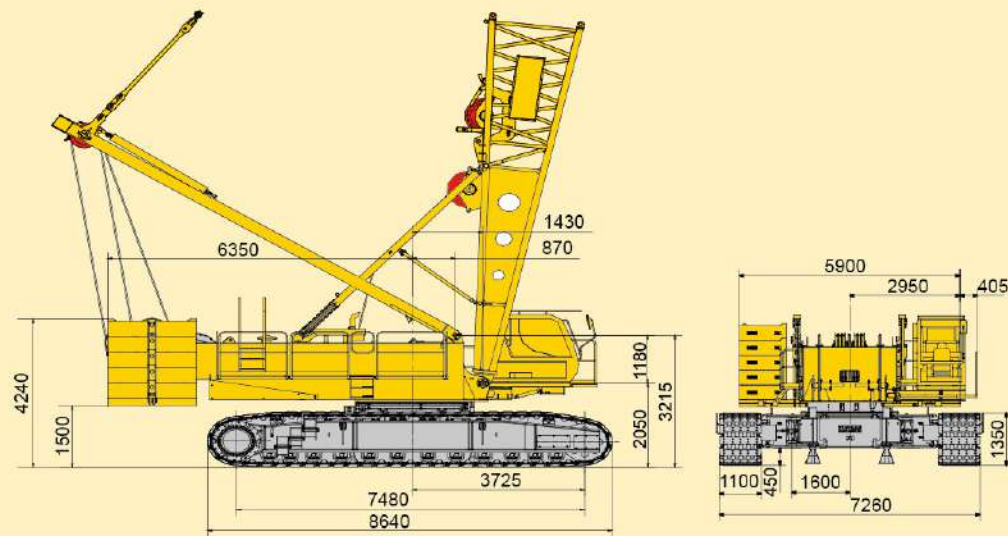
项目 Items	单位 Unit	数值 Data	
		进口配置	国产配置
最大额定起重量 Max. rated lifting capacity	基本型主臂 Basic boom	t	180
	固定副臂 Fixed jib	t	33.5
	变幅副臂 Luffing jib	t	50
最大起重力矩 Max. load moment	t·m	1043.8	
主臂长度 Boom length	m	19-82	
主臂变幅角度 Boom elevating angle	主臂工况 Boom working condition	(°)	30-83
	变幅副臂工况 Luffing jib working condition	(°)	30-85
	固定副臂工况 Fixed jib working condition	(°)	30-85
固定副臂长度 Fixed jib length	m	13-31	
变幅副臂长度 Luffing jib length	m	20-59	
起升机构最大单绳速度(空载、第五层) Winch mechanism max. single line speed (no load, at 5th layer)	m/min	138	120
主臂变幅机构最大单绳速度(第一层) Boom elevating mechanism max. single line speed(at 1th layer)	m/min	2X43	2X34
最大回转速度 Max. slewing speed	r/min	2.0	1.5
最高行走速度 Max. traveling speed	km/h	1.3	1.3
爬坡度 Grade ability	%	30	
平均接地比压 Average ground pressure	Mpa	0.105	
发动机功率 Engine power	kW	242	250
整机质量(主吊钩, 全配重, 19米臂) Mass of the vehicle as a whole (including main hook block and 19m boom)	t	175	
运输状态单件最大质量 Max. mass of single unit in travel configuration	t	37	
运输状态单件最大尺寸(长×宽×高) Max. dimension of single unit in travel configuration (L×W×H)	m	12.5×3.0×3.3	

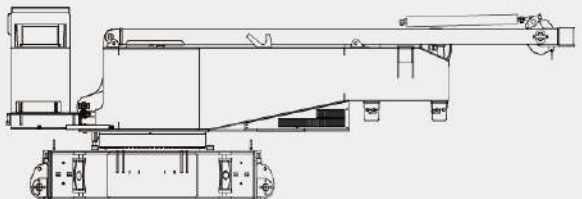
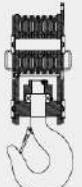
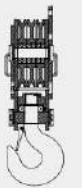
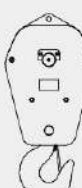
本印刷品所包含的数据, 会随着产品的不断升级而改变, 请以实际产品为准  
Pictures and data in this catalog will change with the update and modification of products, so please take the actual vehicle as reference.

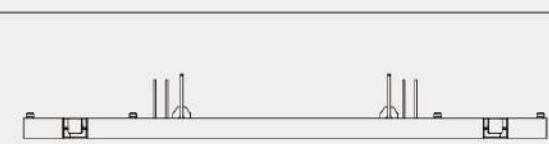
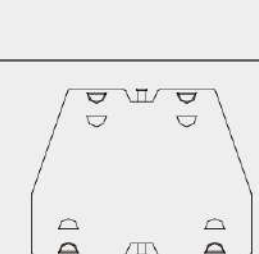

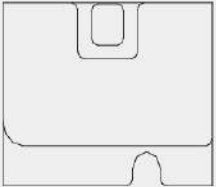
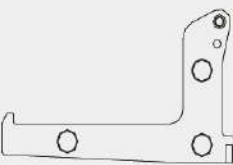
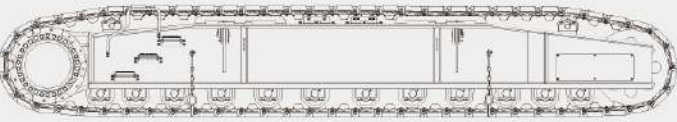
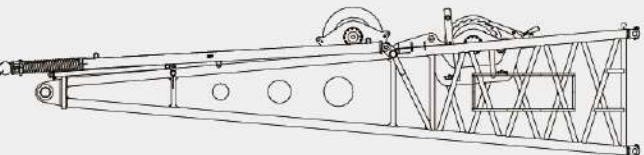
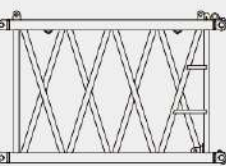
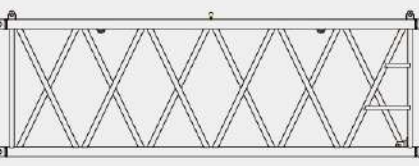
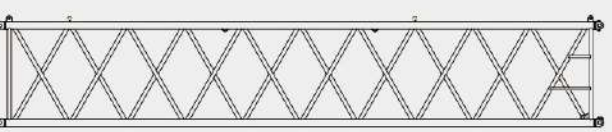
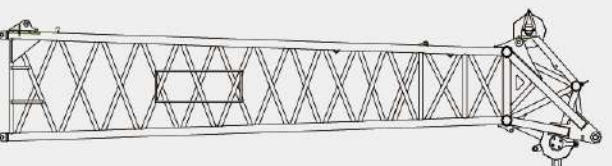

	主机 Main Unit	× 1
	长 L	12500mm
	宽 W	3000mm
	高 H	3300mm
	重量 Weight	37t
	160t吊钩 Capacity Hook Block	× 1
	长 L	2260mm
	宽 W	1080mm
	高 H	750mm
	重量 Weight	2.175t
	100t吊钩 Capacity Hook Block	× 1
	长 L	2035mm
	宽 W	813mm
	高 H	750mm
	重量 Weight	1.665t
	32t吊钩 Capacity Hook Block	× 1
	长 L	1800mm
	宽 W	321mm
	高 H	780mm
	重量 Weight	0.7t
	13.5t吊钩 Capacity Hook Block	× 1
	长 L	1166mm
	宽 W	637mm
	高 H	637mm
	重量 Weight	0.5t
	平衡重托盘 Counterweight Tray	× 1
	长 L	5800mm
	宽 W	1800mm
	高 H	571mm
	重量 Weight	14t
	平衡重 I Counterweight I	× 8
	长 L	1800mm
	宽 W	1280mm
	高 H	413mm
	重量 Weight	5t
	附加平衡重 Additional countweight	× 1
	长 L	1820mm
	宽 W	800mm
	高 H	88mm
	重量 Weight	2.5t

# 主要零部件 Main Parts

	<b>平衡重II</b> Counterweight II ×2 长L 1600mm 宽W 1330mm 高H 893mm 重量 Weight 7t
	<b>平衡重托架</b> Counterweight Bracket ×2 长L 1775mm 宽W 1575mm 高H 915mm 重量 Weight 0.6t
	<b>履带架</b> Track Frame ×2 长L 8250mm 宽W 1500mm 高H 1358mm 重量 Weight 18.8t
	<b>主臂底节臂</b> Boom Butt ×1 长L 9779mm 宽W 2473mm 高H 2279mm 重量 Weight 6.65t
	<b>主臂3米中间节</b> Boom Butt ×1 长L 3140mm 宽W 2140mm 高H 2060mm 重量 Weight 0.629t
	<b>主臂6米中间节</b> Boom Insert ×2 长L 6140mm 宽W 2140mm 高H 2060mm 重量 Weight 0.933t
	<b>主臂12米中间节</b> Boom Insert ×4 长L 12140mm 宽W 2140mm 高H 2060mm 重量 Weight 1.711t
	<b>主臂顶节臂</b> Boom Top 长L 10880mm 宽W 2140mm 高H 2774mm 重量 Weight 3.335t

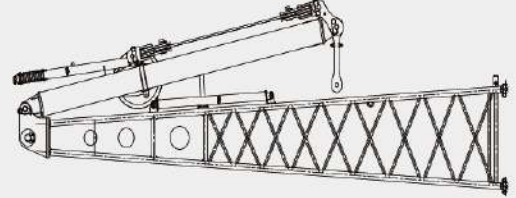
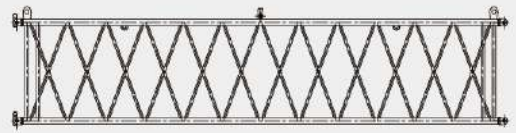
# 主要零部件 Main Parts

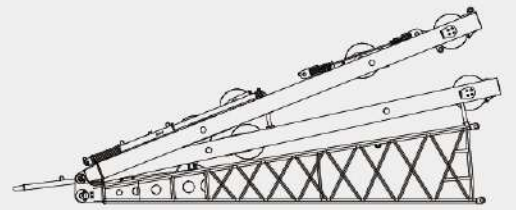
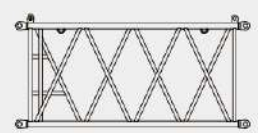
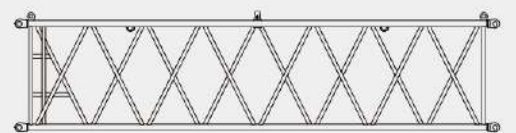
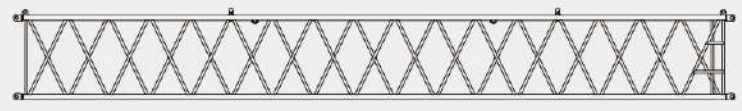
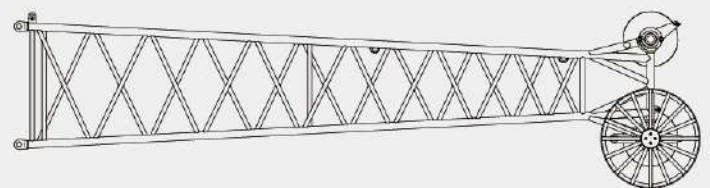
	<b>固定副臂底节臂</b> Fixed Jib Butt 长L 6152mm 宽W 2150mm 高H 2025mm 重量 Weight 1.48t
	<b>固定副臂中间节</b> Fixed Jib Insert ×3 长L 6075mm 宽W 1333mm 高H 1198mm 重量 Weight 0.305t
	<b>固定副臂顶节臂</b> Fixed Jib Top 长L 7453mm 宽W 1265mm 高H 1196mm 重量 Weight 0.706t
	<b>塔臂底节臂</b> Tower Jib Butt 长L 8571mm 宽W 1824mm 高H 3437mm 重量 Weight 4.594t
	<b>塔臂3米中间节</b> Tower Jib Insert 长L 3110mm 宽W 1810mm 高H 1513mm 重量 Weight 0.294t
	<b>塔臂6米中间节</b> Tower Jib Insert 长L 6110mm 宽W 1810mm 高H 1513mm 重量 Weight 0.5t
	<b>塔臂12米中间节</b> Tower Jib Insert ×3 长L 12110mm 宽W 1810mm 高H 1513mm 重量 Weight 0.923t
	<b>塔臂顶节臂</b> Tower Jib Insert 长L 7605mm 宽W 1790mm 高H 1950mm 重量 Weight 1.244t

# 详细介绍 Detailed Introduction

## 上车

### 发动机

采用进口康明斯 QSL9 电喷发动机，额定功率 242kW，额定转速为 2100rpm，最大输出扭矩 1424N·m。排放符合欧洲工程机械第三阶段排放标准。

### 控制系统

智能化计算机集成式可编程控制系统，是该产品的关键核心技术。采用 PLC 可编程控制器，并与常规电气相结合，完成系统的逻辑控制与电比例控制功能，实现起重机的自动控制，大大提高起重机的作业安全性、可靠性和作业效率。本机的操作可以通过电脑的大屏幕显示出来，很方便的实现了人机对话。

### 液压系统

采用电比例控制，开闭回路相结合，LUDV 负荷传感控制，可实现与负载无关的流量分配，具有抗流量饱和功能；发动机功率极限控制，可自动实现功率适应，有效避免发动机熄火。  
液压系统组成：起升系统，变幅系统，回转系统，行走系统，辅助安装系统。  
特点：主泵具有 ΔP 调节功能，可实现主系统微动控制，起升系统、主变幅系统，行走系统均具有高速档及微动档，操作灵敏，动作平稳。回转采用闭式系统，响应快，控制精准，起制动、换向平稳，无冲击。可以满足频繁换向，微动。

### 起升机构

主副起升机构采用内藏式减速机，独立驱动，双泵合流供油，主起升机构采用高强度螺栓安装在转台上，副起升机构通过销轴安装于主管底节臂上，以减轻主机运输重量。主副起升机构可互换使用。  
减速机安装有片式常闭制动器，安全可靠。采用溅油方式润滑，无需维护保养。起升机构还具有换油方便、低噪音、高效率、长寿命等特性。  
起升机构最大单绳速度可达 120m/min，同时具有优良的微速性能。

### 变幅机构

主臂变幅机构为双联卷筒独立驱动，用高强螺栓固定于转台尾部，副臂变幅机构用销轴连接在主臂底节臂上。变幅机构采用内藏式减速机，片式常闭制动器。卷筒设有棘轮锁止装置，以实现机械制动，安全可靠。

### 回转机构

回转机构布置在转台内侧前面，由两个带偏心机构的行星减速机组成。与回转支承内啮合。液压缓冲，具有自由滑转功能。偏心机构可保证减速机和回转支承更好啮合，使回转更平稳，可控常闭、片式制动器，工作可靠，维修方便。

### 回转支承

采用三排滚柱式回转支承，质量稳定可靠。

## Crane Superstructure

### Engine

Imported Cummins QSL9 electronic injection diesel engine, rated output 242kW, rated speed 2100rpm, max. output torque 1424N.m, emission in compliance with European Construction Machinery Stage III.

### Control system

Intelligent computer integrated programmable control system is the key technology of the crane. PLC programmable controller is used, in combination with conventional electrics, to realize logic control and electronic proportional control of the system, and to improve safety, reliability and efficiency for crane operation. Crane operation can be shown by a larger computer display, easy for man-machine interaction.

### Hydraulic system

Electronic proportional control, with combination of open/closed type circuit, LUDV load sense control may realize flow distribution independent of load, and have the function of anti-current quantity saturation; engine power limit control may realize automatic power suit, efficiently avoid engine shut-down.  
Hydraulic system composition: hoist system, luffing system, slewing system, travel system, and auxiliary assembly system.  
Features: Main pump has ΔP regulation function, may realize main system fine motion control; hoist system, main luffing system and travel system have high speed gear and fine motion gear for sensitive operation and smooth movement. Slewing gear is closed type system, quick response, accurate control, stable starting, braking and direction change, no impact, may satisfy operation of frequent direction change and fine motion control.

### Hoist winch

Main/auxiliary winch has built-in speed reducer with independent drive, and oil supplied by combination of two pumps, main hoist winch is installed with high-strength bolt on turntable and auxiliary hoist winch installed with pin shaft on boom base to reduce basic machine transport weight. Main/auxiliary hoist winch has exchangeable use. Speed reducer has disc type constant closed brake with oil-bath lubrication for safe and reliable work without maintenance. Hoist winch also features easy oil change, low noise, high efficiency and long service life. Hoist winch max. single line speed is 120m/min, with good fine speed performance.

### Luffing gear

Boom luffing gear is a twin drum independent drive unit, fixed on turntable tail with high-strength bolt; jib luffing gear connected on boom base with pin shaft. Luffing gear has built-in speed reducer, and disc type constant closed brake. Winch drum has a ratchet locking device to realize mechanical braking, safe and reliable.

### Slewing gear

Slewing gear is arranged inside the front of turntable, made up by two eccentricity planetary reducer, and external meshed with slewing ring, has the function of hydraulic buffering and free-swing. The eccentricity planetary gear can ensure good coupling for reducer and slewing ring, make stable slewing, and controllable constant closed disc type brake reliable work and easy maintenance.

### Slewing ring

Slewing ring is a 3-row roller type slewing bearing, with stable and reliable quality.

# 详细介绍 Detailed Introduction

### 主机平衡重

主机平衡重和中央平衡重结合，同时增强作业稳定性和整机后倾翻稳定性。主机平衡重和中央平衡重均可进行自拆装(选配)，主机平衡重与转台的连接增加了销轴油缸，消除了平衡重在拆装过程中的安全隐患。

主机平衡重共重 60.5t, 包括:  
平衡重托盘 14t/件 共1件  
平衡重 I 5t/件 共8件  
平衡重 II 2t/件 共2件  
附加平衡重 2.5t  
中央平衡重共重 15.2t, 包括:  
托架 0.6t/件 共2件  
平衡重 II 7t/件 共2件

### 操纵室

操纵室采用钢制框架结构，正面配置有整体式夹层玻璃，其余玻璃均为钢化玻璃。装有可调节座椅、按人机工程学布置的全套操纵仪表和控制装置，配置风道式冷暖空调、音响、灭火装置、闭路监视系统等，宽敞舒适。工作时，操纵室可调整俯仰角度，扩大视野，方便操作；运输时，操纵室可从侧方转到前方，减小运输宽度。

### 转台

转台采用高强度钢板焊接而成，整体结构型式采用大箱形框架式等强度梁结构，两侧工字形主立板用箱形梁左右联接。  
该结构的优点为整体抗弯、抗扭能力强，稳定性好，转台内空间较大，有利于保养及维护。  
转台通过回转支承与下车联接。转台上安装有驾驶室、起升机构、变幅机构、发动机、桅杆、臂架及配重等重要部件。

## 下车

下车包括车架、履带架、行走机构。车架和履带架采用插入式连接。

### 车架

车架采用高强度钢板、箱形结构，中间设置横隔板，加强其抗扭刚度，结构简单，承载能力强，刚性好。

### 履带架

包括履带架和四轮一带。履带架采用箱形结构，和车架连接部位局部加强，中间设置横隔板。两个履带架对称布置。四轮一带采用高强度合金铸钢铸造而成，履带架宽度为 1.1m。履带架上安装有销轴油缸，用桅杆上的辅助安装油缸(选配)可方便实现履带架的自拆装。

### 行走机构

行走机构采用内藏式行星齿轮减速机、轴向柱塞式变量马达驱动，减速机带有液压释放行走制动器，安全可靠。左右两套行走机构可同步操作，也可单独操纵，以实现直行和转弯。

### Counterweight

The combination of car-body counterweight and central counterweight is to increase operation stability and overall stability against backwards tilting. The car-body counterweight and central counterweight have self assembly/disassembly(optional), and a pin shaft cylinder is added for connection of car-body counterweight and turntable, eliminated the hidden danger for safety of counterweight assembly/disassembly.

Car-body counterweight is 60.5t, includes:  
counterweight tray 14t/piece, total 1 piece;  
counterweight I 5t/piece, total 8 pieces;  
counterweight II 2t/piece, total 2 pieces;  
counterweight installation attachment 2.5t;  
Central counterweight is 15.2t, includes:  
counterweight frame 0.6t/piece, total 2 pieces;  
counterweight II 7t/piece, total 2 pieces.

### Operator's cabin

Operator's cabin is steel frame structure, the front windshield is provided with overall sandwich glass, other glass is all hardened glass, equipped with adjustable seat, ergonomic designed instruments and control devices, air-conditioner, CD player, fire extinguisher, closed circuit monitor and etc., spacious and comfortable. When working, the cabin's angle can be adjusted to enlarge the view field; when traveling, the cabin can be turned from the side to the front in order to reduce the transport width.

### Turntable

Turntable is large box type structure welded by high-strength steel, with both side "工" type upright plate connected with box type beam at left and right.  
The structure advantage is strong overall tensile strength, good stability and large inside space, helpful for maintenance.  
It connects with the undercarriage through slewing ring, operator's cabin, winch system, luffing system, engine, mast, boom and counterweight etc. respectively arranged on the turntable at different positions.

## Crane Carrier

Crane carrier comprises car-body, track frame, and propel unit. Car-body and track frame take insert-type connection.

### Car-body

Car-body is made of high-strength steel and welded in box type structure, with cross panel installed in the middle to strengthen its stiffness against torsion, simple structure, high loading capacity and well rigidity.

### Track frame

Crawler travel unit consists of track frame, track shoe, drive sprocket, idler roller, track roller and travel motor. Track frame is box-type structure, the connection place to frame is strengthened partially, and cross panel is installed in the middle of it. Two track frames are symmetrically arranged. The four-roller and one-track are made of high-strength alloy casting steel. The track shoe width is 1.1m. On track frame installed pin shaft cylinder(option), with assistant cylinder on mast, it is easy for track frame assembly and disassembly.

### Crawler travel unit

Crawler travel unit uses built-in planetary gear reducer and axial piston variable displacement motor, the reducer has hydraulic release service brake, safe and reliable. Two crawler travel units at left and right can be operated not only synchronously but also independently to realize straight drive and turning around.

# 详细介绍

## Detailed Introduction

### 行走速度

变量马达可以实现无级变速，最高速度 1.3 公里 / 小时。行走时，设备运行平稳，可实现快速行走。



### 作业设备

作业设备包括主臂、固定副臂、变幅副臂、桅杆、吊钩等。

### 主臂

主臂由底节臂、顶节臂和中间节组合而成，主臂为空间桁架式结构，底节臂、顶节臂为锥形变截面结构，顶节臂可联接变幅副臂、固定副臂及臂端单滑轮机构，无需换臂头，中间节为等截面结构。主臂用高强度优质钢管焊接而成，臂架顶部与根部用钢板加强，以利于传递载荷。主臂长度为 19 ~ 82m。  
组成：底节臂 9m、中间节臂 3m×1、中间节臂 6m×2、中间节臂 12m×4、顶节臂 10m×1。

### 固定副臂

主臂长 25 ~ 70m 范围内可安装固定副臂进行作业，固定副臂长度组合为 13 ~ 31m，与主臂间的安装角分为 15° 和 30° 两种。  
组成：底节臂 6m、中间节臂 6m×3、顶节臂 7m。

### 变幅副臂

主臂长 25 ~ 58m 范围内可安装变幅副臂进行作业，变幅副臂长度组合为 20 ~ 59m。  
组成：底节臂 7m、中间节臂 3m×1、中间节臂 6m×1 中间节臂 12m×3、顶节臂 7m。

### 桅杆

桅杆为箱形双肢结构，具有良好的整体稳定性。桅杆上安装有辅助拆装油缸（选配），用于主臂底节臂、中央平衡重及履带架自拆装，也可用于其它辅助吊装。一键扳起功能可使桅杆起落操作更方便。

### 吊钩

标准配置：160t吊钩、100t吊钩、32t吊钩、13.5t吊钩。



### 安全装置

安全装置包括：力矩限制器、主副提升防过卷装置、主副提升防过放装置、主副变幅棘爪装置、起重臂角度限位、主副臂防后倾系统、闭路监视系统、示高灯、风速仪、电子水平仪、防雷击系统、蜂鸣器及警示灯、功能互锁、应急功能、发动机功率极限载荷调节及失速保护、故障自诊断系统及黑匣子功能、断电保护等。

### Travel speed

Variable displacement motor can realize infinite variable speeds, with max. speed 1.3 km/h, travel stable and fast.



### Lifting Operation Parts

The lifting operation parts devices comprise:boom, fixed jib, luffing jib, mast, hook block.

### Boom

Boom comprises boom base, boom top and boom insert, with lattice type structure; boom base and boom top are tapered variable section, and boom top may be connected with luffing jib, fixed jib and single top without replacing boom head; boom insert is variable section. Boom is welded by high-strength steel tube, boom top and boom foot are reinforced by steel plates for load transfer. Boom length: 19m~82m. Composition: boom base 9m, boom insert 3m×1, boom insert 6m×2, boom insert 12m×4, boom top 10m×1.

### Fixed jib

Fixed jib can be attached and operated within the range of boom length 25m~70m, fixed jib length combination is 13m~31m, with two offset angle of 15° and 30°.  
Composition: jib base 6m, jib insert 6m×3, jib top 7m.

### Luffing jib

Luffing jib can be attached and operated within the range of boom length 25m~58m, luffing jib length combination is 20m~59m.  
Composition: jib base 7m, jib insert 3m×1, jib insert 6m×1, jib insert 12m×3, jib top 7m.

### Mast

Mast is box-type structure of two limbs with good overall stability, and installed assistant cylinder for self assembly/disassembly(option) for boom base, central ballast and track frame, and also for other auxiliary parts lifting. The one-switch operation may be easy for mast raising and lowering.

### Hook block

Standard equipment:160t capacity hook block, 100t capacity hook block, 32t capacity hook block, 13.5t capacity hook block.



### Safety Devices

The safety protection devices comprise: load moment limiter, main/auxiliary winch over-wound protection, main/auxiliary winch over-release protection, winch ratchet locking device, boom angle limit, boom/jib backstop system, closed circuit monitor system, height mark lamp, anemometer, level gauge, lightning proof system, buzzer and warning lamp, two-way hydraulic lock, emergency function, engine power limit and extreme load regulation, stall protection, self diagnosis, black box and power cut-out protection.

# 详细介绍

## Detailed Introduction

### 力矩限制器

检测功能：力矩限制器能自动检测出起重臂的角度、起重载荷大小。  
显示功能：实时的显示当前实际载荷，工作半径，起重臂角度和当前风速。  
警示功能：如果检测到实际载荷超过额定载荷，起重臂超过极限角度，力矩限制器发出报警并限制当前动作。

### 主、副提升防过卷装置

当主、副卷扬上升到最大高度时，高度限位检测开关起作用，显示器中过卷保护指示灯亮，同时禁止卷扬起升动作。

### 主、副提升过放装置

当主、副提升卷扬过放时，安装在卷筒内部的三圈保护开关检测到卷筒上的钢丝绳剩下三圈，仪表板上的指示灯亮，同时禁止卷扬落动作。

### 棘爪锁止装置

该功能用于锁定变副卷扬，起重臂降落的时候必须打开该装置，否则不能降落，用于保护臂架在非工作时安全停放。

### 起重臂角度限位

起重臂角度限位是由力矩限制器和安装在臂架上的行程开关双重控制的，主臂工况时主臂仰角达到 83°、变幅副臂及固定副臂工况主臂仰角达到 85° 时，控制系统将自动停止主臂的起臂动作，主臂仰角达到 30° 时，控制系统将自动停止主臂的落臂动作，同时蜂鸣器发出声音报警。

### 主副臂防后倾系统

主臂、变幅副臂上安装有防后倾装置，当主副臂有后倾趋势时，防后倾装置可提供足够的防后倾力防止臂架后倾。

### 闭路监视系统

司机室安装有闭路监视系统，通过安装在转台尾部及臂架上的摄像头和显示器，司机可即时观察起升机构、变幅机构的工作情况。

### 声光报警系统

在履带起重机移动或做回转动作的时候警告灯闪烁并且发出声音报警。

### 三色力矩报警灯

由三种颜色组成，负载在 90% 以下时“绿灯”亮，表示起重机在安全区域运行，负载在 90%-100% 的时候“黄灯”亮，表示起重机在已接近额定载荷范围，负载在 100%-102% 以上时“红灯”亮，表示起重机已经超载，在危险区域，控制系统自动切断起重机向危险的方向运行。

### Lode moment limiter

Detection function: automatically detect boom angle and lifting load.  
Display function: real time display current actual load, working radius and boom angle.  
Warning function: automatically send out warning signal and stop crane operation when detecting actual load exceeding rated load and boom out of limit angle.

### Main/Auxiliary winch over-wound protection device

When main/auxiliary winch hoists up to a certain lifting height, an over-wound warning lamp on instrument panel lights on, at the same time, load moment limiter stops crane hoisting up operation.

### Main/Auxiliary winch over-release protection device

A rope-end limiter is set on main and auxiliary hoist winch to protect wire rope from over-release, when only three turns of rope left on the drum, it stops drum hoisting down, and at the same a warning lamp on instrument panel lights up.

### Winch ratchet locking device

Winch drum has a ratchet locking device, and it must be turned on when lowering boom, otherwise boom cannot be lowered. The device is used to stow the boom for safety.

### Boom angle limit

Boom angle limit is controlled by load moment limiter and hoist limit switch on boom. When boom angle is more than 83°, and luffing jib and fixed jib angle is more than 85°, both load moment limiter and hoist limit switch stop boom raising. When boom angle is less than 30°, load moment limiter stops boom lowering and give a sound warning.

### Boom/Jib backstop system

Boom and luffing jib is installed a backstop device, when boom and jib have backwards tilting, the backstop device may provide enough force to prevent boom and jib from tilting backwards.

### Closed circuit monitor system

The operator's cabin has closed circuit monitor system, through the camera and monitor installed on turntable tail and boom, operator can keep watch on hoist winch and luffing gear working situation.

### Audio/Video warning

When crawler crane is moving and slewing, there is light and sound for warning.

### Load moment tricolor warning lamp

The lamp comprises 3 colors, when crane loading is below 90% of total rated lifting load, "Green Lamp" lights on to indicate crane is running in safety area; when crane loading is in 90%~100% of total rated lifting load, "Yellow Lamp" lights on to indicate crane is close to total rated lifting load; when crane loading is above 100%~102% of total rated lifting load, "Red Lamp" and "Yellow Lamp" light on at the same time to indicate crane is overload; In dangerous area, control system can automatically cut off crane movement to dangerous direction.

# 详细介绍 Detailed Introduction

## 应急功能

当控制器损坏时，可以使用应急开关替代手柄，将起重机操作到安全状态。主卷扬、副卷扬、主变幅、副变幅、回转等动作均支持应急操作功能。

## Emergency function

When a breakdown occurs in the control system, a emergency switch may be used to replace the control to bring the machine into safety status, main/auxiliary winch, main/auxiliary luffing gear, slewing gear are supported for the emergency control function.

## 黑匣子

该功能可以将司机的操作及设备的运行参数记录下来，有利于分析事故原因。

## Black box

The black box function is to record the operation data of operator and equipment, helpful for analysis of accident causes.

## 照明灯

装置在转台前方、臂架上和操纵室内，用于为夜间工作提供照明。

## Illumination lamp

There are illumination lamps at front of turntable, on boom and in operator's cabin for night operation.

## 示高灯

安装在臂架顶部，作为高空警示。

## Height mark lamp

Boom tip has a height mark lamp for high level operation warning.

## 风速仪

实时检测当前风速，传送到操纵室的监视器上，提醒司机操作的安全性。

## Anemometer

Anemometer at boom head can detect current wind speed and send wind signal to a monitor in operator's cabin to alert operator for safety.

# 自拆装 (选配) Self Assembly/Disassembly (Optional Function)

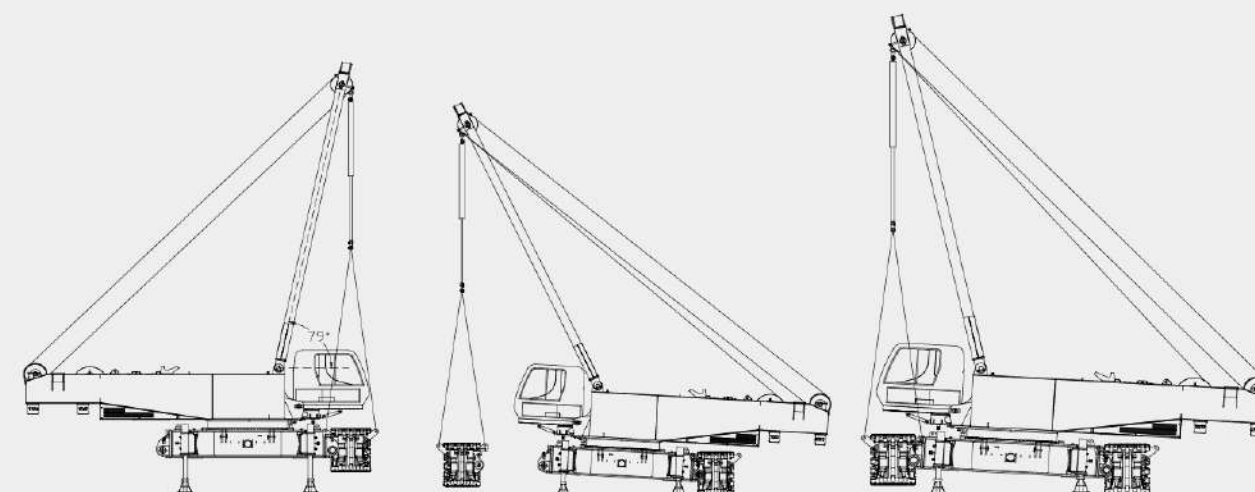
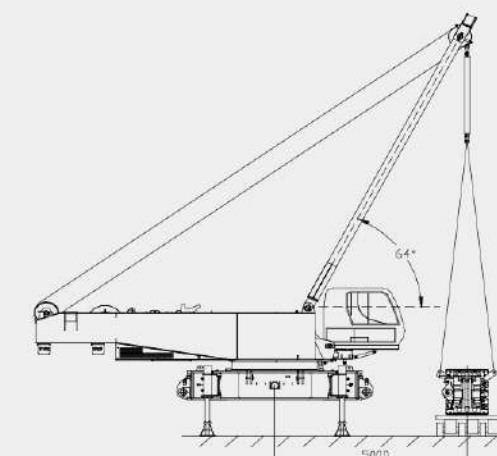
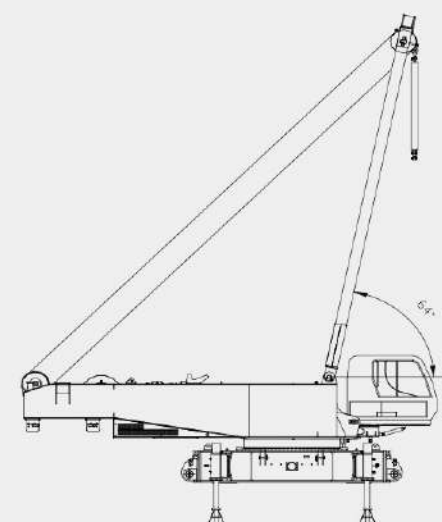
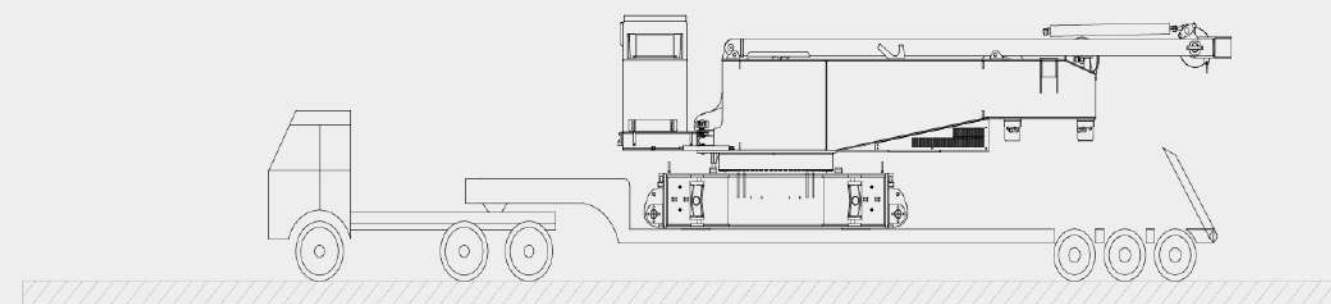

# 主臂臂节组合/主臂工况 Boom Combinations/Boom Working Condition

臂长 Boom length (m)	底节臂 Boom butt 9m	中间节臂 Boom insert			顶节臂 Boom top 10m
		3m	6m	12m	
19	1	-	-	-	1
22	1	1	-	-	1
25	1	-	1	-	1
28	1	1	1	-	1
31	1	-	-	1	1
34	1	1	-	1	1
37	1	-	1	1	1
40	1	1	1	1	1
43	1	-	-	2	1
46	1	1	-	2	1
49	1	-	1	2	1
52	1	1	1	2	1
55	1	-	-	3	1
58	1	1	-	3	1
61	1	-	1	3	1
64	1	1	1	3	1
67	1	-	-	4	1
70	1	1	-	4	1
73	1	-	1	4	1
76	1	1	1	4	1
79	1	-	2	4	1
82	1	1	2	4	1

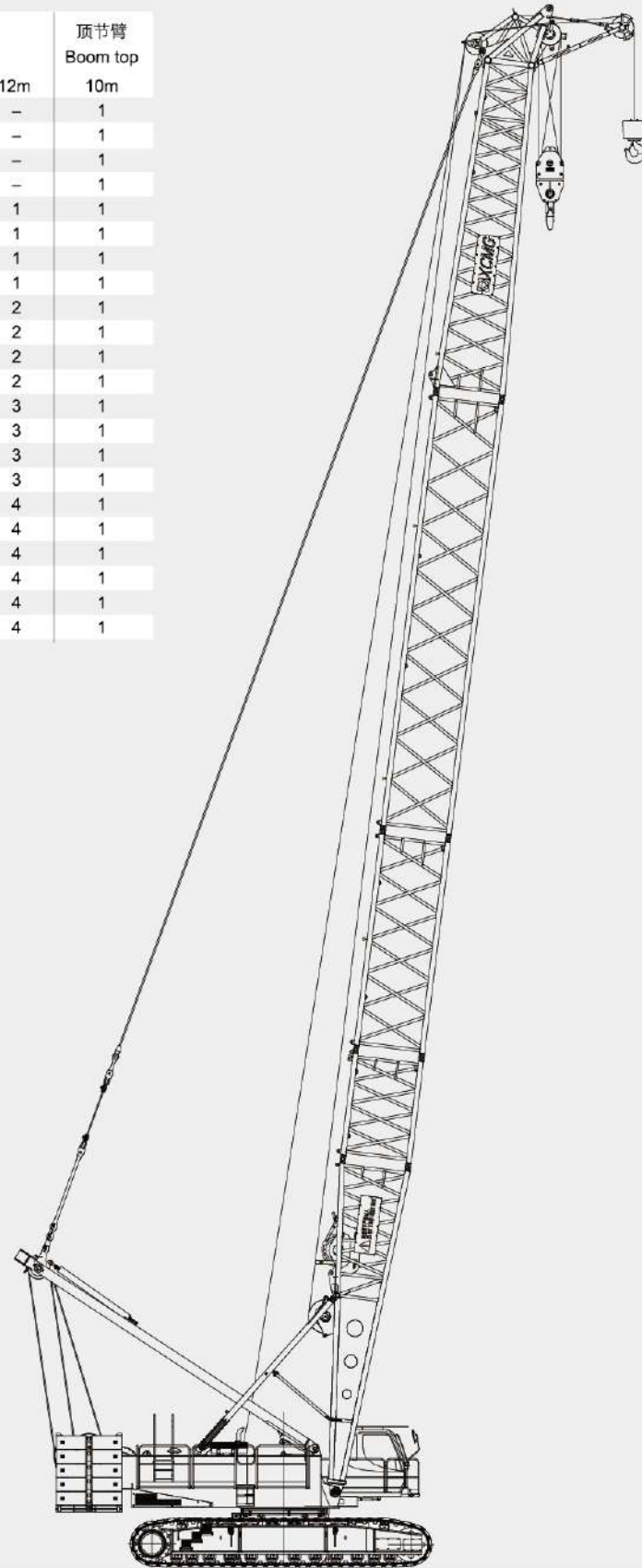

# 主臂作业范围 Boom Working Area

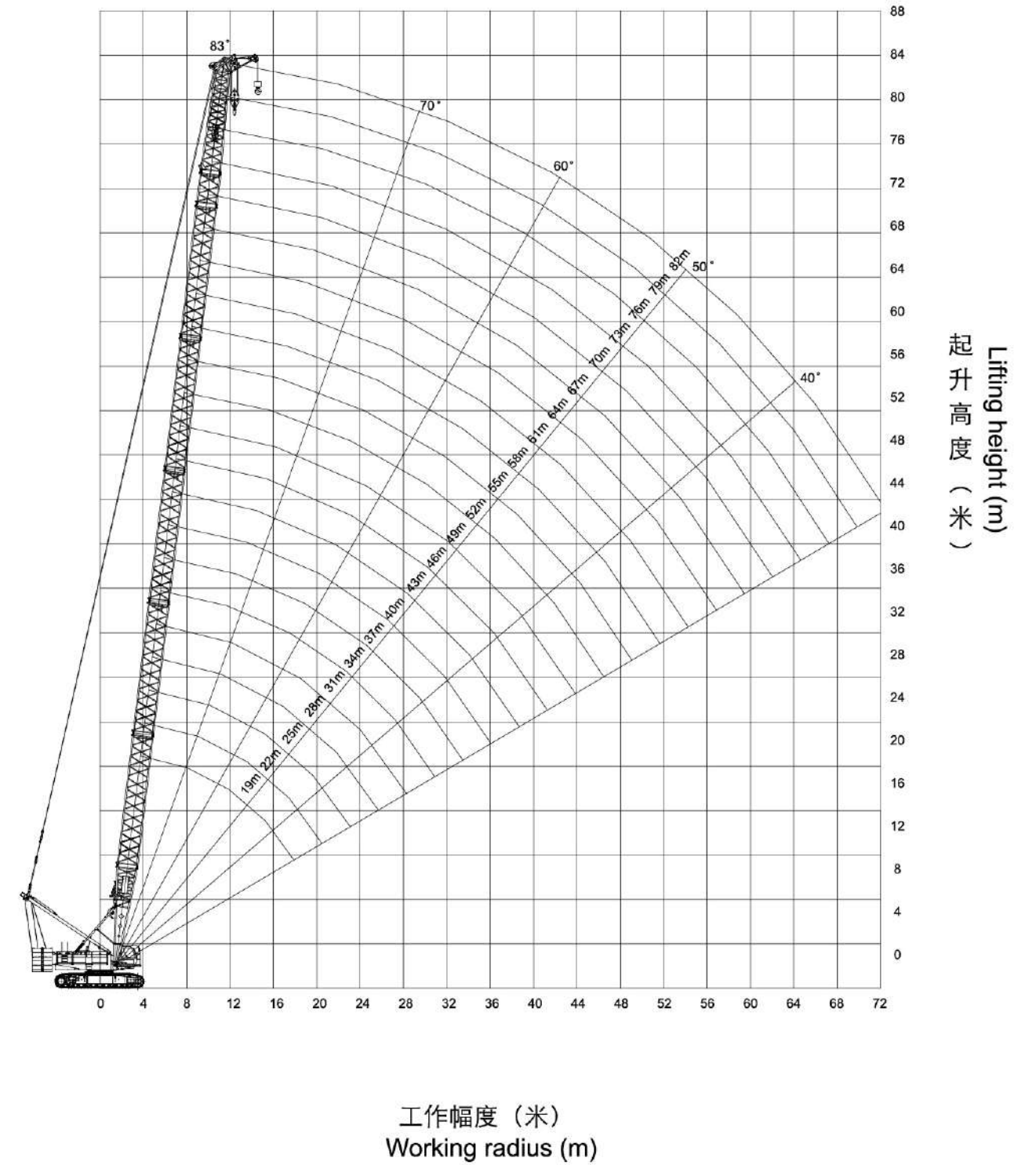

# 主臂工况载荷表 Boom Working Condition and Lifting Load Chart

幅度 Radius (m)	臂长 Boom length (m)											幅度 Radius (m)
	19	22	25	28	31	34	37	40	43	46	49	
5	180.0											5
6	166.8	146.4	143.5	138.5								6
7	141.8	134.1	132.6	130.2	124.8							7
8	121.4	121.5	121.5	121.5	117.9	113.6	109.6	102.4				8
9	105.9	106.0	106.1	106.1	105.4	104.2	103.2	100.1	89.9	82.3	75.2	9
10	90.8	90.7	90.7	90.6	90.5	90.0	89.3	88.3	87.3	81.1	74.2	10
12	69.5	69.7	69.7	69.6	69.5	69.4	69.3	69.2	68.7	67.9	67.3	12
14	56.0	56.2	56.3	56.1	56.0	55.9	55.9	55.7	55.5	55.4	55.2	14
16	46.4	46.7	46.9	46.8	46.7	46.5	46.5	46.4	46.2	46.1	45.9	16
18		39.7	40.0	39.9	39.8	39.7	39.6	39.5	39.3	39.2	39.0	18
20		34.2	34.5	34.6	34.6	34.4	34.4	34.2	34.0	33.9	33.8	20
22			30.2	30.3	30.4	30.2	30.2	30.1	29.9	29.7	29.6	22
24				26.9	26.9	26.8	26.9	26.7	26.5	26.4	26.2	24
26					24.1	24.0	24.1	23.9	23.7	23.6	23.4	26
28						21.7	21.5	21.7	21.5	21.4	21.2	28
30							19.5	19.6	19.5	19.3	19.2	30
32								17.8	17.6	17.6	17.4	32
34									16.1	16.1	15.9	34
36										14.1	14.6	36
38											13.4	38
40												40
42												42

# 主臂工况载荷表 Boom Working Condition and Lifting Load Chart

幅度 Radius (m)	臂长 Boom length (m)											幅度 Radius (m)
	52	55	58	61	64	67	70	73	76	79	82	
10	67.9	62.0										10
12	65.4	59.7	54.7	50.0	45.4	41.2	37.6					12
14	55.2	54.9	53.3	48.2	43.6	40.0	36.1	32.9	30.1	27.3	24.8	14
16	45.8	45.5	45.4	45.2	42.3	38.4	34.8	31.7	28.6	26.2	23.8	16
18	38.9	38.6	38.5	38.3	38.2	37.5	34.1	30.6	27.8	25.2	22.8	18
20	33.6	33.3	33.2	33.1	32.9	32.6	32.5	29.6	26.6	24.0	21.6	20
22	29.5	29.2	29.0	28.9	28.8	28.4	28.3	28.1	25.5	23.0	20.8	22
24	26.1	25.8	25.7	25.5	25.4	25.0	24.9	24.7	24.6	22.1	20.1	24
26	23.3	23.0	22.9	22.7	22.6	22.2	22.1	21.9	21.8	21.4	19.2	26
28	20.9	20.7	20.5	20.4	20.2	19.9	19.8	19.6	19.5	19.2	18.5	28
30	18.9	18.6	18.5	18.3	18.2	17.9	17.8	17.6	17.5	17.2	17.0	30
32	17.2	16.9	16.8	16.6	16.5	16.2	16.0	15.8	15.7	15.4	15.3	32
34	15.7	15.4	15.3	15.1	15.0	14.7	14.5	14.3	14.2	13.9	13.8	34
36	14.3	14.1	14.0	13.8	13.6	13.3	13.2	13.0	12.9	12.6	12.5	36
38	13.1	12.9	12.8	12.6	12.5	12.2	12.0	11.8	11.7	11.4	11.3	38
40	12.0	11.9	11.7	11.6	11.4	11.1	11.0	10.8	10.7	10.4	10.2	40
42	11.0	10.9	10.8	10.6	10.4	10.2	10.0	9.8	9.7	9.4	9.3	42
44	10.2	10.1	9.9	9.8	9.6	9.3	9.2	9.0	8.9	8.6	8.4	44
46	9.3	9.3	9.1	9.0	8.9	8.5	8.4	8.2	8.1	7.8	7.7	46
48		8.6	8.4	8.2	8.1	7.8	7.7	7.5	7.4	7.1	7.0	48
50			7.8	7.6	7.5	7.2	7.1	6.9	6.7	6.5	6.3	50
52				7.0	6.9	6.6	6.5	6.3	6.2	5.9	5.7	52
54					6.5	6.4	6.1	5.9	5.7	5.6	5.3	54
56						5.8	5.6	5.4	5.2	5.1	4.8	56
58							5.1	5.0	4.8	4.6	4.4	58
60								4.5	4.3	4.2	3.9	60
62									3.9	3.8	3.5	62
64										3.6	3.4	64
66											3.1	66
68												68
70												70



# 臂头单滑轮载荷表 Boom single top lifting load chart

幅度 Radius (m)	主臂 Boom (m)											幅度 Radius (m)
	19	22	25	28	31	34	37	40	43	46	49	
5	13.5											5
6	13.5	13.5	13.5	13.5								6
7	13.5	13.5	13.5	13.5	13.5	13.5	13.5					7
8	13.5	13.5	13.5	13.5	13.5	13.5	13.5	13.5	13.5	13.5		8
9	13.5	13.5	13.5	13.5	13.5	13.5	13.5	13.5	13.5	13.5	13.5	9
10	13.5	13.5	13.5	13.5	13.5	13.5	13.5	13.5	13.5	13.5	13.5	10
12	13.5	13.5	13.5	13.5	13.5	13.5	13.5	13.5	13.5	13.5	13.5	12
14	13.5	13.5	13.5	13.5	13.5	13.5	13.5	13.5	13.5	13.5	13.5	14
16	13.5	13.5	13.5	13.5	13.5	13.5	13.5	13.5	13.5	13.5	13.5	16
18		13.5	13.5	13.5	13.5	13.5	13.5	13.5	13.5	13.5	13.5	18
20		13.5	13.5	13.5	13.5	13.5	13.5	13.5	13.5	13.5	13.5	20
22			13.5	13.5	13.5	13.5	13.5	13.5	13.5	13.5	13.5	22
24				13.5	13.5	13.5	13.5	13.5	13.5	13.5	13.5	24
26					13.5	13.5	13.5	13.5	13.5	13.5	13.5	26
28					13.5	13.5	13.5	13.5	13.5	13.5	13.5	28
30						13.5	13.5	13.5	13.5	13.5	13.5	30
32							13.5	13.5	13.5	13.3	13.2	32
34								12.0	11.8	11.7	11.6	34
36								11.2	10.6	10.4	10.4	36
38									9.9	9.6	9.4	38
40										8.6	8.3	40
42											7.4	42

幅度 Radius (m)	主臂 Boom (m)										幅度 Radius (m)
	52.0	55.0	58.0	61.0	64.0	60.0	70.0	73.0	76.0		
9	13.5										9
10	13.5	13.5	13.5	13.5							10
12	13.5	13.5	13.5	13.5	13.5	13.5	13.5				12
14	13.5	13.5	13.5	13.5	13.5	13.5	13.5	13.5	13.5	13.5	14
16	13.5	13.5	13.5	13.5	13.5	13.5	13.5	13.5	13.5	13.5	16
18	13.5	13.5	13.5	13.5	13.5	13.5	13.5	13.5	13.5	13.5	18
20	13.5	13.5	13.5	13.5	13.5	13.5	13.5	13.5	13.5	13.5	20
22	13.5	13.5	13.5	13.5	13.5	13.5	13.5	13.5	13.5	13.5	22
24	13.5	13.5	13.5	13.5	13.5	13.5	13.5	13.5	13.5	13.5	24
26	13.5	13.5	13.5	13.5	13.5	13.5	13.5	13.5	13.5	13.5	26
28	13.5	13.5	13.5	13.5	13.5	13.5	13.5	13.5	13.5	13.5	28
30	13.5	13.5	13.5	13.5	13.5	13.5	13.5	13.5	13.5	13.4	30
32	13.1	12.9	12.7	12.6	12.4	12.2	12.1	11.9	11.7		32
34	11.5	11.4	11.3	11.1	11.0	10.9	10.7	10.6	10.5		34
36	10.3	10.2	9.9	9.8	9.6	9.5	9.2	9.1	8.8		36
38	9.2	9.0	8.8	8.7	8.5	8.3	8.2	8.0	7.6		38
40	8.1	7.9	7.7	7.6	7.4	7.3	7.1	7.1	6.7		40
42	7.1	7.0	6.8	6.6	6.5	6.4	6.2	6.0	5.8		42
44	6.3	6.2	6.0	5.9	5.6	5.4	5.2	5.1	5.0		44
46	5.7	5.5	5.2	5.1	4.9	4.7	4.5	4.3	4.2		46
48		4.8	4.4	4.4	4.1	4.1	3.8	3.8	3.6		48
50			3.9	3.7	3.6	3.5	3.3	3.0	2.9		50
52				3.4	3.2	3.0	2.9	2.8	2.7		52
54					2.8	2.7	2.5	2.4	2.3	2.1	54
56						2.2	2.1	1.9	1.8	1.6	56

# 固定副臂臂节组合/副臂工况 Fixed Jib Combinations/Jib Working Condition

副臂长度 Jib length (m)	6m底节臂 Jib base	6m中间节 Jib insert	7m顶节臂 Jib top
13	1	-	1
19	1	1	1
25	1	2	1
31	1	3	1

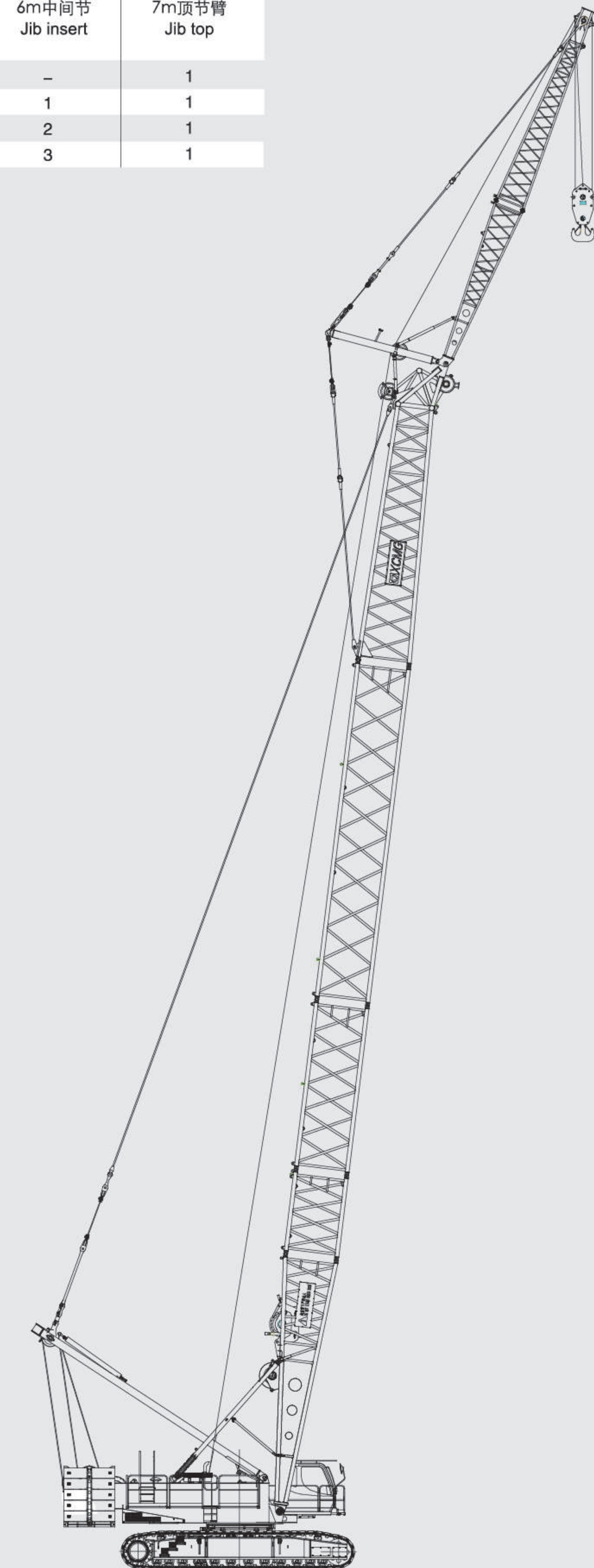

# 固定副臂工作范围图 Fixed Jib Working Area

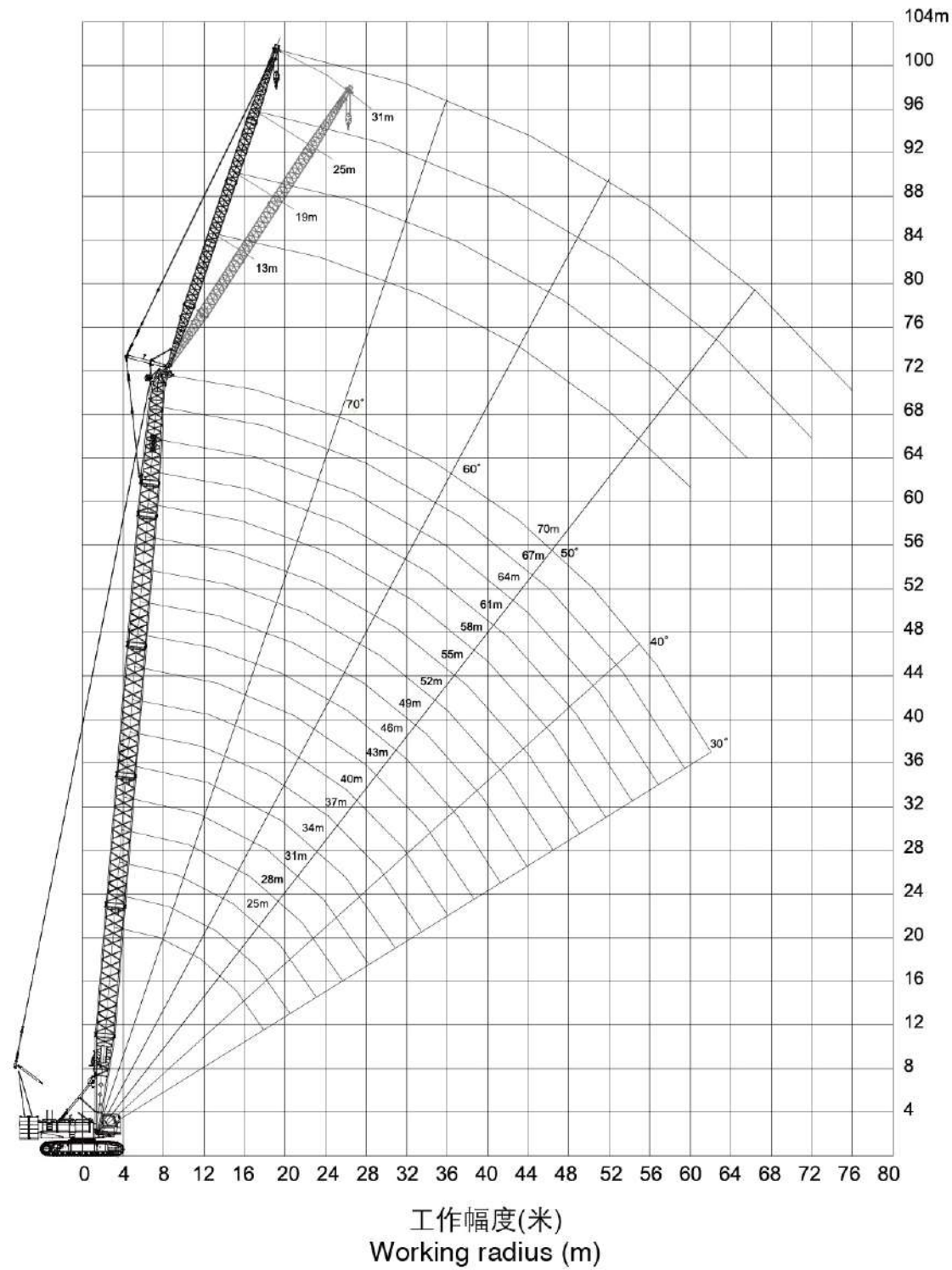

# 固定副臂工况载荷表 Fixed Jib Lifting Load Chart

副臂角度 Jib angle (°)	15°																	
	25				31				37				43					
	主臂长度 Boom length (m)		副臂长度 Jib length (m)		主臂长度 Boom length (m)		副臂长度 Jib length (m)		主臂长度 Boom length (m)		副臂长度 Jib length (m)		主臂长度 Boom length (m)		副臂长度 Jib length (m)			
副臂长度 Jib length (m)	幅度 Radius (m)	13	19	25	31	13	19	25	31	13	19	25	31	13	19	25	31	
9		33.5																
10		32.3				32.1												
12		30.5	22.9			30.4	22.6			30.2				29.9				
14		28.8	21.5	17.5		29.0	21.4	17.6		28.8	21.4	16.5		28.7	21.1			
16		27.3	20.1	16.4	13.0	27.6	20.3	16.6	12.8	27.6	20.4	16.5		27.6	20.2	16.4		
18		26.0	19.0	15.3	12.2	26.3	19.1	15.7	12.1	26.3	19.4	15.6	12.0	26.5	19.3	15.5	11.8	
20		23.7	18.0	14.4	10.8	25.2	18.2	14.8	11.5	25.3	18.5	14.8	11.5	25.5	18.5	14.8	11.4	
22		22.7	17.1	13.7	10.3	23.1	17.4	14.0	10.2	24.5	17.7	14.1	10.2	24.5	17.7	14.1	10.9	
24		21.9	16.2	12.9	9.7	22.3	16.6	13.4	9.8	22.5	17.0	13.4	9.7	23.7	17.0	13.5	9.7	
26		21.2	15.4	12.2	9.3	21.5	15.9	12.7	9.4	21.8	16.2	12.9	9.3	21.0	16.4	12.9	9.3	
28		20.4	14.7	10.5	8.7	20.4	15.1	12.1	8.9	19.5	15.6	12.3	9.0	18.7	15.8	12.4	9.0	
30		19.0	14.0	10.0	8.2	18.3	14.4	11.5	8.4	17.6	14.9	11.7	8.6	16.8	15.1	11.9	8.7	
32		17.3	13.5	9.5	7.8	16.7	13.9	9.9	7.9	15.9	14.4	11.2	8.1	15.3	14.6	11.3	8.3	
34		15.5	12.9	9.1	7.3	15.1	13.3	9.5	7.5	14.4	13.8	9.8	7.8	13.6	14.0	10.9	7.9	
36			12.5	8.7	6.9	13.6	12.9	9.2	7.1	13.1	13.3	9.4	7.4	12.5	12.7	9.6	7.5	
38			12.1	8.3	6.5	12.5	12.5	8.8	6.8	12.0	12.4	9.0	7.1	11.4	11.7	9.2	7.2	
40			11.5	7.9	6.2		11.8	8.4	6.5	10.9	11.3	8.7	6.7	10.3	10.7	8.8	6.9	
42				7.6	6.0		10.8	8.0	6.2	10.0	10.4	8.3	6.4	9.4	9.8	8.6	6.6	
44				7.3	5.6		9.9	7.7	5.9	9.1	9.5	8.0	6.2	8.7	8.9	8.2	6.3	
46					5.5			7.4	5.7		8.8	7.7	5.9	7.9	8.3	7.9	6.0	
48					5.3			7.2	5.4		8.1	7.4	5.6	7.3	7.6	7.6	5.8	
50					5.1			7.0	5.3		7.4	7.1	5.4		7.0	7.1	5.6	
52									5.1			6.9	5.2		6.3	6.6	5.4	
54									5.0			6.6	5.1		5.8	6.1	5.2	
56									4.9				5.0			5.6	5.0	
58													4.9			5.2	4.9	
60													4.7			4.8	4.8	
62																	4.7	
64																		4.4
66																		4.0

# 固定副臂工况载荷表 Fixed Jib Lifting Load Chart

# 固定副臂工况载荷表 Fixed Jib Lifting Load Chart

副臂角度 Jib angle (°)	15°																		
	49				55				61				67				70		
主臂长度 Boom length (m)																			
副臂长度 Jib length (m)	13	19	25	31	13	19	25	31	13	19	25	31	13	19	25	31	13	19	
幅度 Radius (m)																			
12	29.5				29.1														
14	28.3	20.8			27.9	20.5			27.3							19.1		16.1	
16	27.4	19.9	16.1		26.9	19.7	15.8		26.5	19.4					18.9	17.0		16.0	14.3
18	26.4	19.2	15.4	11.7	26.0	19.0	15.2	11.5	25.9	18.7	15.0				18.6	16.8	14.8	15.7	14.3
20	25.4	18.4	14.7	11.2	25.2	18.2	14.5	11.1	25.0	18.1	14.4	10.9			18.1	16.7	14.2	15.5	14.1
22	24.5	17.7	14.0	10.8	24.5	17.6	14.0	10.6	23.6	17.4	13.9	10.5			17.8	16.3	13.6	15.1	13.8
24	22.8	17.0	13.5	9.6	22.0	16.9	13.4	10.3	20.8	16.9	13.3	10.1			17.4	15.9	13.2	14.7	13.5
26	20.2	16.4	12.9	9.2	19.4	16.3	12.9	9.2	18.6	16.3	12.8	9.1			16.9	15.6	12.7	14.3	13.1
28	18.0	15.9	12.4	9.0	17.4	15.8	12.4	8.9	16.6	15.8	12.3	8.8			15.7	15.2	12.3	13.9	12.7
30	16.2	15.3	12.0	8.6	15.5	15.3	11.9	8.6	14.8	15.0	11.9	8.5			14.1	14.3	11.9	13.5	12.5
32	14.5	14.7	11.5	8.4	14.0	14.3	11.6	8.3	13.3	13.6	11.5	8.3			12.6	12.8	11.4	12.3	12.1
34	13.1	13.5	11.1	8.0	12.6	12.8	11.1	8.0	12.0	12.3	11.1	8.1			11.4	11.7	11.1	11.1	11.2
36	12.0	12.2	10.6	7.7	11.3	11.7	10.7	7.7	10.9	11.1	10.8	7.8			10.3	10.6	10.6	10.0	10.3
38	10.9	11.1	9.3	7.4	10.3	10.7	10.4	7.4	9.7	10.1	10.3	7.5			9.3	9.5	9.7	9.0	9.2
40	9.8	10.2	9.0	7.0	9.3	9.6	9.9	7.1	8.9	9.1	9.3	7.2			8.3	8.5	8.9	8.1	8.3
42	9.0	9.4	8.6	6.7	8.4	8.8	8.8	6.8	8.0	8.3	8.5	6.9			7.6	7.8	7.9	7.3	7.6
44	8.2	8.5	8.4	6.5	7.8	8.0	8.2	6.6	7.3	7.5	7.7	6.7			6.8	7.2	7.4	6.6	6.9
46	7.5	7.9	8.1	6.2	7.1	7.4	7.6	6.4	6.6	6.9	7.1	6.4			6.2	6.4	6.6	5.9	6.3
48	6.8	7.2	7.4	5.9	6.5	6.7	6.9	6.1	6.0	6.2	6.5	6.2			5.7	5.9	6.0	5.4	5.7
50	6.3	6.5	6.8	5.8	6.0	6.2	6.3	5.9	5.5	5.7	6.0	6.0			5.0	5.3	5.5	5.0	5.2
52	5.8	6.0	6.3	5.6	5.5	5.7	5.8	5.7	5.0	5.2	5.3	5.6			4.6	4.8	5.1	4.6	4.8
54	5.2	5.5	5.8	5.4	5.0	5.2	5.3	5.4	4.6	4.8	5.0	5.1			4.3	4.6	4.6	4.1	4.4
56		5.2	5.3	5.2	4.5	4.8	5.0	5.1	4.3	4.4	4.6	4.6			3.9	4.1	4.2	3.7	3.9
58		4.7	4.9	5.0	4.2	4.5	4.6	4.7	3.8	4.0	4.2	4.4			3.5	3.8	3.9	3.4	3.6
60		4.4	4.5	4.8		4.0	4.2	4.3	3.5	3.7	3.8	4.1			3.1	3.3	3.6	2.9	3.2
62			4.2	4.3		3.7	3.9	4.0	3.2	3.4	3.5	3.6			2.8	3.0	3.3	2.6	2.9
64			3.9	4.0		3.3	3.6	3.7	2.8	3.1	3.2	3.3			2.5	2.7	2.8	2.3	2.6
66				3.6			3.3	3.4		2.8	2.9	3.0			2.2	2.4	2.7	2.1	2.3
68				3.5			3.0	3.1		2.5	2.6	2.9			2.0	2.1	2.4		2.1
70				3.2				2.7			2.9					2.4	2.6		
72											2.6					2.1	2.3		2.0
74												2.3				2.0	2.1		

副臂角度 Jib angle (°)	30°																					
	25				31				37				43									
主臂长度 Boom length (m)																						
副臂长度 Jib length (m)	13	19	25	31	13	19	25	31	13	19	25	31	13	19	25	31						
幅度 Radius (m)																						
12	25.1																					
14	24.2							23.8					23.5					23.2				
16	23.2	17.6						23.0	17.3				22.8					22.4				
18	22.5	16.7						22.3	16.6				22.0	16.4				21.8	16.2			
20	21.8	16.0	12.7					21.7	15.8	12.8			21.5	15.8	12.5			21.3	15.7			
22	20.7	15.2	11.0					21.2	15.2	12.0			21.0	15.3	12.0			20.8	15.2	11.9		
24	19.9	14.5	10.5	8.6				20.1	14.7	10.6	8.5		20.5	14.8	10.5	8.5		20.4	14.7	11.3	8.3	
26	18.7	13.4	10.1	8.1				19.3	13.8	10.1	8.1		19.6	14.1	10.1	8.1		20.0	14.1	10.0	7.9	
28	17.9	12.6	9.6	7.7				18.5	13.0	9.8	7.8		18.8	13.4	9.7	7.7		19.4	13.3	9.7	7.7	
30	17.1	12.1	9.2	7.4				17.8	12.6	9.4	7.4		18.0	13.0	9.5	7.4		17.6	13.0	9.3	7.4	
32	16.7	11.8	8.8	7.0				17.0	11.8	9.1	7.1		16.6	12.2	9.1	7.1		16.0	12.6	9.1	7.1	
34	15.8	11.7	8.5	6.7				15.7	11.5	8.7	6.7		15.1	11.5	8.8	6.8		14.4	11.9	8.8	6.8	
36		11.3	8.2	6.5				14.2	11.4	8.4	6.5		13.6	11.2	8.5	6.5		13.1	11.5	8.5	6.5	
38		10.5	7.9	6.2				13.1	10.9	8.0	6.3		12.6	11.1	8.3	6.3		11.9	11.1	8.2	6.3	
40		10.4	7.5	6.0				11.9	10.9	7.6	6.1		11.4	11.0	8.0	6.1		11.0	10.8	8.0	6.1	
42			7.1	5.8				10.5	7.3	5.9	10.5	10.6	7.8	5.9	9.9	10.6	7.8	5.9	10.6	7.8	5.9	
44			6.7	5.6				10.1	7.2	5.7	9.6	10.1	7.4	5.7	9.1	9.7	7.6	5.7	9.7	7.6	5.7	
46			6.6	5.4				9.7	6.8	5.5		9.4	7.0	5.6	8.3	9.0	7.2	5.6	9.0	7.2	5.6	
48				5.2					6.4	5.4		8.7	6.8	5.5	7.6	8.1	7.2	5.5	8.1	7.2	5.5	
50				5.0					6.4	5.2		8.0	6.6	5.3	6.9	7.6	6.8	5.4	7.6	6.8	5.4	
52				5.0					6.2	5.0			6.4	5.2		6.9	6.4	5.2	6.9	6.4	5.2	
54											4.8			6.2	5.1		6.3	6.4	5.1	6.3	6.4	5.1
56											4.8			6.2	4.9		5.8	6.2	4.9	5.8	6.2	4.9
58												4.6			4.7			5.8	4.7	5.8	4.9	
60															4.7			5.3	4.7	5.3	4.7	
62																4.5			5.0	4.5	5.0	4.5
64																						4.5
66																						4.4
68																						4.4
70																						4.1

# 固定副臂工况载荷表 Fixed Jib Lifting Load Chart

副臂角度 Jib angle (°)	30°																		
	49				55				61				67				70		
主臂长度 Boom length (m)																			
副臂长度 Jib length (m)	13	19	25	31	13	19	25	31	13	19	25	31	13	19	25	31	13	19	
幅度 Radius (m)																			
14	23.8																		
16	22.1				21.7				21.2						16.9			14.5	
18	21.5	15.9			21.1	15.6			20.8						17.0			14.4	
20	21.0	15.4			20.6	15.2			20.4	14.9					17.0	14.6		14.4	12.3
22	20.5	14.9	11.7		20.2	14.7	11.5		19.9	14.5	11.3				16.7	14.2		14.2	12.3
24	20.2	14.5	11.3		19.8	14.3	11.1		19.5	14.1	11.0				16.5	13.8	10.7	14.0	12.3
26	19.8	14.1	9.9	7.8	19.4	14.0	10.7	7.8	19.1	13.8	10.4	7.6			16.3	13.6	10.4	13.7	12.2
28	18.9	13.7	9.6	7.5	18.3	13.6	9.5	7.4	17.6	13.4	9.4	7.4			15.9	13.2	10.1	13.4	12.1
30	17.0	12.9	9.3	7.3	16.3	13.2	9.2	7.2	15.6	12.9	9.1	7.1			15.1	12.9	9.0	13.1	11.8
32	15.4	12.6	9.1	7.1	14.7	12.6	8.9	7.0	14.1	12.6	8.8	6.9			13.4	12.6	8.8	12.9	11.6
34	13.8	12.3	8.8	6.8	13.3	12.3	8.7	6.7	12.6	12.2	8.6	6.7			12.1	12.2	8.5	11.8	11.5
36	12.6	11.5	8.6	6.5	12.1	11.9	8.5	6.5	11.5	11.9	8.5	6.5			11.0	11.7	8.3	10.7	11.3
38	11.4	11.1	8.3	6.3	10.9	11.2	8.3	6.3	10.3	11.0	8.3	6.3			9.9	10.5	8.2	9.6	10.2
40	10.5	10.8	8.1	6.1	9.9	10.6	8.0	6.1	9.5	10.0	8.1	6.1			8.9	9.5	7.9	8.6	9.3
42	9.4	10.1	7.8	5.9	9.0	9.5	7.9	5.9	8.5	9.1	7.8	5.9			8.2	8.6	7.8	7.9	8.4
44	8.8	9.2	7.6	5.7	8.3	8.8	7.7	5.8	7.7	8.4	7.6	5.8			7.3	8.0	7.6	7.1	7.7
46	7.9	8.6	7.3	5.5	7.6	8.1	7.5	5.6	7.0	7.7	7.4	5.6			6.7	7.2	7.5	6.5	6.9
48	7.2	7.7	7.3	5.4	6.9	7.4	7.3	5.5	6.4	6.9	7.3	5.4			6.0	6.5	7.0	5.8	6.3
50	6.7	7.2	7.0	5.3	6.2	6.7	7.1	5.4	5.9	6.4	6.7	5.3			5.6	5.9	6.3	5.3	5.8
52	6.0	6.5	6.6	5.2	5.7	6.2	6.5	5.2	5.4	5.9	6.2	5.2			4.9	5.4	5.9	4.9	5.2
54	5.5	6.0	6.5	5.1	5.2	5.7	6.0	5.2	5.0	5.4	5.7	5.0			4.7	4.9	5.4	4.5	4.8
56		5.5	6.0	5.0	4.9	5.2	5.5	5.1	4.5	4.9	5.2	5.0			4.2	4.5	4.9	4.0	4.4
58		5.2	5.4	4.9	4.4	4.9	5.1	4.9	4.1	4.4	4.8	4.9			3.7	4.2	4.5	3.5	4.0
60		4.7	5.0	4.8	4.1	4.4	4.7	4.8	3.6	4.1	4.4	4.8			3.4	3.7	4.2	3.2	3.7
62			4.7	4.6		4.1	4.4	4.7	3.3	3.6	4.1	4.4			3.1	3.4	3.7	2.9	3.2
64			4.3	4.6		3.7	4.0	4.4	3.0	3.3	3.6	3.9			2.8	3.1	3.4	2.6	2.9
66			4.0	4.3		3.4	3.7	4.0		3.0	3.3	3.6			2.4	2.7	3.1	2.3	2.6
68				4.0			3.4	3.7		2.7	3.0	3.3			2.1	2.4	2.7	2.0	2.3
70								3.6			3.0	3.4				2.5	2.8		
72																			
74																			
76																			

# 变幅副臂臂节组合 Luffing Jib Combinations

塔臂臂节组合表 Luffing Jib Combination

副臂长度 Jib length (m)	7m底节臂 Jib base	3m中间节 Jib insert	6m中间节 Jib insert	12m中间节 Jib insert	7m顶节臂 Jib top
20	1	-	1	-	1
23	1	1	1	-	1
26	1	-	-	1	1
29	1	1	-	1	1
32	1	-	1	1	1
35	1	1	1	1	1
38	1	-	-	2	1
41	1	1	-	2	1
44	1	-	1	2	1
47	1	1	1	2	1
50	1	-	-	3	1
53	1	1	-	3	1
56	1	-	1	3	1
59	1	1	1	3	1

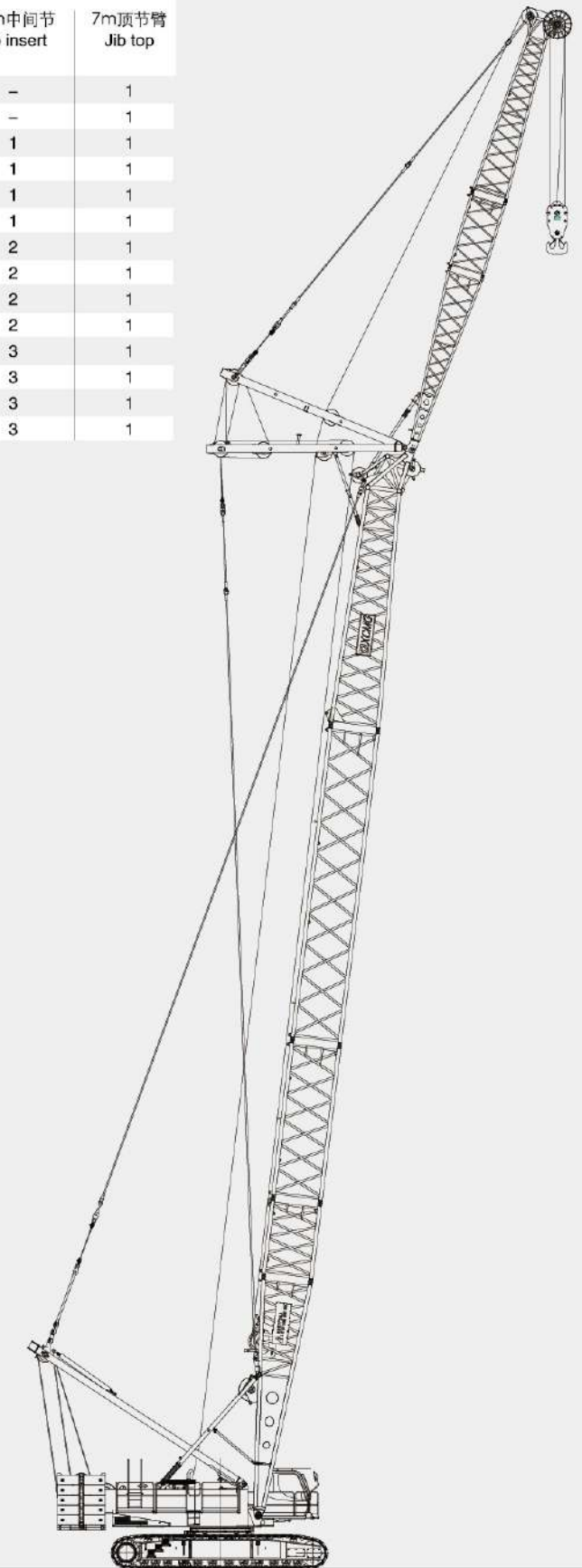

# 变幅副臂工作范围图 Luffing Jib Working Area

# 变幅副臂工况载荷表 Luffing jib lifting load chart

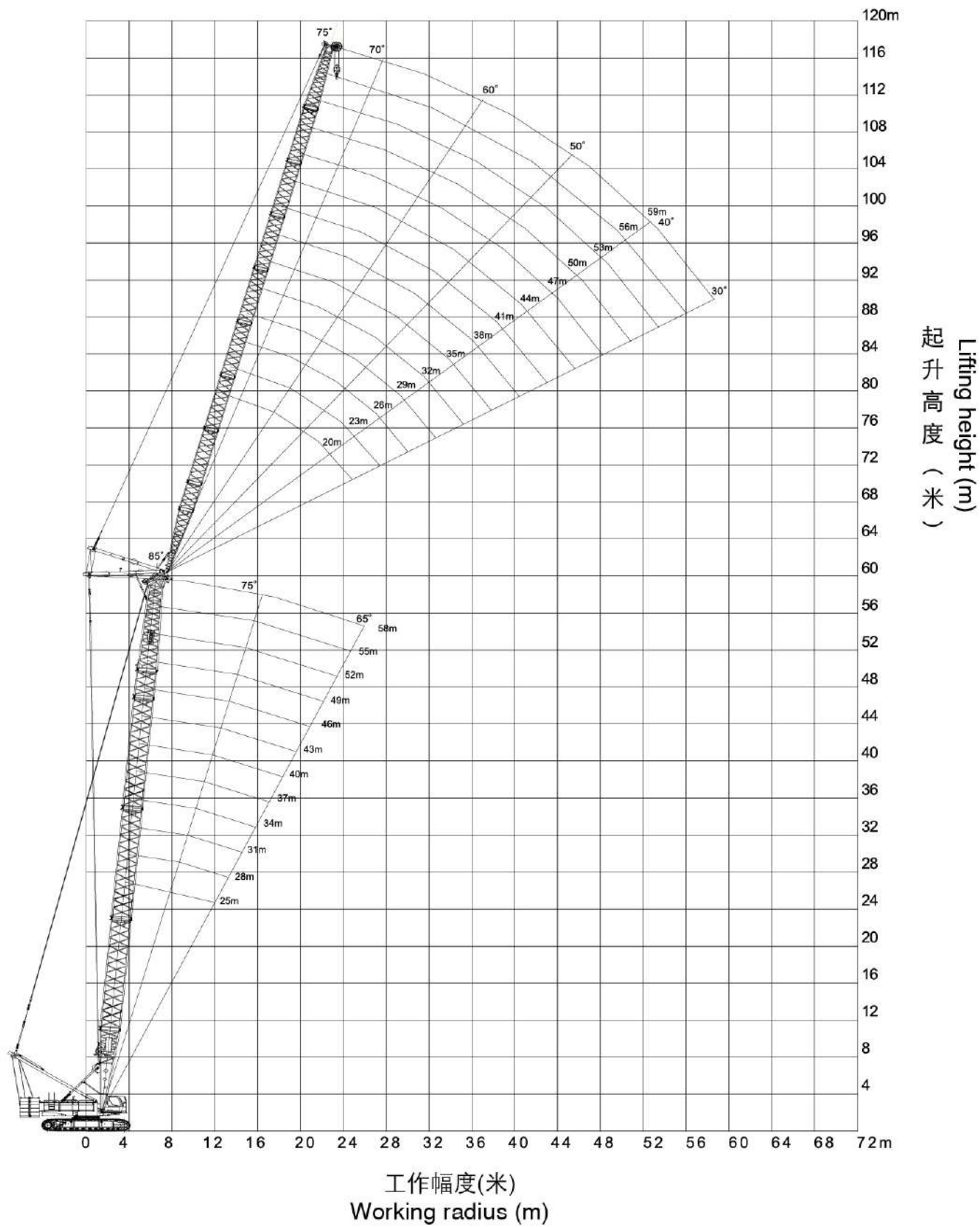

主角度 Boom angle (°)	85°													
主臂 Boom (m)	25													
副臂 Jib (m)	20	23	26	29	32	35	38	41	44	47	50	53	56	59
幅度 Radius (m)														
10	50.0													
12	48.3	46.0	43.9											
14	40.1	38.9	38.4	37.5	36.3	34.6								
16	33.1	32.9	32.3	31.6	31.1	30.4	30.1	29.2						
18	27.1	27.1	27.1	27.1	27.1	26.7	26.4	25.8	24.1	20.0	17.3			
20	23.1	23.1	23.1	23.1	22.9	22.9	22.5	21.9	21.6	18.9	16.4	14.1	12.2	9.6
22		20.7	20.7	20.5	20.5	20.3	20.1	19.6	19.3	17.0	14.8	12.7	9.9	8.5
24		18.1	18.1	17.8	17.8	17.8	17.7	17.6	17.2	15.5	13.3	10.6	9.0	7.6
26			16.2	15.8	15.8	15.8	15.7	15.7	15.6	14.2	12.2	9.5	8.1	6.7
28				14.1	13.9	13.9	13.9	13.9	13.8	13.1	10.4	8.9	7.3	6.2
30					12.5	12.5	12.5	12.3	12.3	12.1	9.5	8.1	6.6	5.8
32					11.2	11.2	11.1	11.1	11.0	11.0	8.9	7.3	6.1	5.4
34						10.3	10.3	10.3	9.7	9.3	8.2	6.8	5.7	4.9
36							9.6	9.1	9.0	8.5	7.6	6.2	5.4	4.6
38								8.5	8.1	7.8	7.1	5.8	5.1	4.2
40									7.5	7.1	6.6	5.5	4.7	3.9
42									6.8	6.3	6.2	5.3	4.4	3.6
44										5.9	5.7	4.9	4.1	3.4
46											5.4	4.7	3.9	3.2
48												4.5	3.7	3.0
50													4.3	2.8
52														3.3
54														2.6
56														2.5

配重  
Counterweight (t) 65+20

变幅副臂工况载荷表  
Luffing jib lifting load chart

主角度 Boom angle (°)	85°																
	主臂 Boom (m)																
副臂 Jib (m)	20	23	26	29	32	35	38	41	44	47	50	53	56	59			
幅度 Radius (m)																	
12	48.9	46.5	44.1														
14	40.6	39.4	38.6	37.2	36.2												
16	32.7	32.7	32.4	31.7	31.2	30.6	30.2	28.7									
18	27.6	27.6	27.6	27.6	27.3	26.6	26.4	25.8	23.6	19.7							
20	23.7	23.3	23.3	23.2	23.2	23.2	23.2	21.9	21.6	18.7	16.2	14.0	12.0				
22	20.8	20.7	20.7	20.7	20.7	20.3	20.0	19.6	19.2	16.9	14.6	12.6	9.9	8.5			
24		18.2	18.2	17.9	17.9	17.9	17.9	17.5	17.1	15.4	13.3	11.3	8.9	7.6			
26			15.7	15.7	15.7	15.7	15.7	15.7	15.5	14.1	12.1	9.5	8.0	6.7			
28				14.0	14.0	13.9	13.8	13.8	13.8	12.9	11.0	8.8	7.2	6.1			
30					12.7	12.2	12.2	12.2	12.2	11.9	9.4	8.0	6.5	5.7			
32						11.5	10.9	10.9	10.9	10.9	10.7	8.8	7.3	6.0	5.2		
34							10.2	10.2	10.2	9.6	9.2	8.1	6.7	5.6	4.8		
36								9.5	9.0	8.8	8.4	7.5	6.2	5.3	4.4		
38									8.4	8.0	7.7	6.9	5.8	4.9	4.2		
40										7.7	7.4	7.0	6.5	5.4	4.6	3.9	
42											6.7	6.3	6.0	5.1	4.3	3.6	
44												5.8	5.7	4.9	4.1	3.3	
46													5.3	4.6	3.8	3.1	
48														4.9	4.4	3.6	2.9
50															4.2	3.4	2.7
52																3.2	2.6
54																	2.4
配重 Counterweight (t)	65+20																

变幅副臂工况载荷表  
Luffing jib lifting load chart

主角度 Boom angle (°)	85°																		
	主臂 Boom (m)																		
副臂 Jib (m)	20	23	26	29	32	35	38	41	44	47	50	53	56	59					
幅度 Radius (m)																			
12	49.6	47.0																	
14	42.1	40.1	38.6	37.2															
16	34.1	34.0	33.5	32.7	31.4	30.6	30.1												
18	28.6	28.6	28.4	27.8	27.3	26.8	26.4	25.9	22.7										
20	23.8	23.8	23.7	23.7	23.6	23.6	22.5	22.7	21.2	18.2	15.7	13.6							
22	20.1	20.1	20.1	20.1	20.1	20.1	20.1	19.4	19.0	16.7	14.6	12.5	9.8	8.5					
24		17.8	17.8	17.8	17.8	17.8	17.7	17.4	17.1	15.3	13.1	11.2	8.9	7.6					
26			16.2	15.8	15.8	15.8	15.7	15.6	15.3	13.9	12.0	9.4	8.0	6.7					
28				14.4	13.9	13.9	13.9	13.9	13.8	13.8	12.6	10.9	8.6	7.2	5.9				
30					12.6	12.5	12.3	12.5	12.3	12.0	11.8	9.3	7.8	6.5	5.5				
32						11.2	11.1	11.1	11.0	10.8	10.8	8.6	7.2	5.9	5.1				
34								9.8	10.3	9.8	9.8	9.1	8.0	6.6	5.5	4.8			
36									9.6	8.9	8.7	8.4	7.4	6.0	5.2	4.4			
38										8.2	7.9	7.6	6.8	5.6	4.8	4.0			
40											7.6	7.2	6.9	6.3	5.3	4.5	3.8		
42												6.7	6.2	5.9	5.1	4.2	3.5		
44													5.7	5.6	4.7	3.9	3.3		
46														5.3	5.0	4.5	3.8	3.0	
48															4.8	4.2	3.5	2.8	
50																4.0	3.2	2.6	
52																	3.1	2.4	
54																		3.0	2.4
配重 Counterweight (t)	65+20																		

# 变幅副臂工况载荷表 Luffing jib lifting load chart

主角度 Boom angle (°)	85°														
	主臂 Boom (m)														
副臂 Jib (m)	20	23	26	29	32	35	38	41	44	47	50	53	56	59	
幅度 Radius (m)															
12	47.1														
14	39.5	39.5	38.8	37.2											
16	33.9	33.8	33.7	32.9	32.0	30.6									
18	28.9	28.9	28.4	27.8	27.4	26.8	26.4	25.8	22.2						
20	24.1	24.1	24.1	23.9	23.9	23.6	23.2	22.7	21.4	17.8	15.3				
22	20.6	20.2	20.2	20.2	20.2	20.2	19.8	19.4	19.0	16.6	14.5	12.4	10.7	8.4	
24		18.5	18.5	18.3	18.3	17.9	17.7	17.3	17.0	15.1	13.0	11.2	8.7	7.5	
26		16.1	16.1	15.9	15.9	15.6	15.6	15.5	15.2	13.7	11.9	9.4	8.0	6.6	
28			13.9	13.9	13.9	13.8	13.8	13.8	13.6	12.6	10.8	8.5	7.2	5.9	
30				12.2	12.2	12.2	12.2	12.2	12.2	11.6	9.2	7.8	6.5	5.4	
32					11.1	11.0	10.8	10.8	10.8	10.7	8.5	7.1	5.8	5.1	
34						10.0	9.9	9.7	9.7	9.0	7.9	6.5	5.5	4.7	
36							9.2	9.2	8.8	8.5	8.2	7.2	5.9	5.1	4.3
38								8.5	8.1	7.9	7.5	6.7	5.5	4.7	4.0
40									7.5	7.2	6.8	6.2	5.2	4.4	3.7
42										6.6	6.2	5.9	4.9	4.2	3.4
44											6.0	5.6	5.5	4.6	3.8
46												5.1	5.0	4.4	3.6
48													4.8	4.2	3.5
50														4.0	3.3
52															3.7
54															3.0
配重 Counterweight (t)	65+20														

# 变幅副臂工况载荷表 Luffing jib lifting load chart

主角度 Boom angle (°)	85°														
	主臂 Boom (m)														
副臂 Jib (m)	20	23	26	29	32	35	38	41	44	47	50	53	56	59	
幅度 Radius (m)															
14	30.9	30.9	30.9												
16	27.5	27.5	27.5	27.5	27.5										
18	25.2	25.2	25.2	25.2	25.2	25.2	25.2	25.2	25.2						
20	23.2	23.2	23.2	23.2	23.2	23.2	23.2	23.2	22.8	20.9	17.4	15.0			
22	20.5	20.2	20.2	20.2	20.2	20.2	20.2	20.2	19.3	18.9	16.6	14.4	12.3	10.6	
24	18.2	18.2	18.2	18.2	18.2	17.8	17.5	17.2	16.9	14.9	12.9	11.2	8.7	7.5	
26		16.2	15.8	15.8	15.8	15.7	15.7	15.5	15.2	13.6	11.7	10.0	7.9	6.6	
28			14.0	14.0	13.8	13.8	13.8	13.8	13.6	12.4	10.7	8.4	7.1	5.9	
30				12.4	12.4	12.1	12.1	12.1	12.1	11.4	9.7	7.7	6.4	5.4	
32					11.0	10.9	10.9	10.9	10.7	10.6	8.4	7.1	5.8	5.0	
34						9.9	9.7	9.7	9.7	9.7	9.5	7.8	6.5	5.3	4.6
36							9.0	9.0	9.0	8.5	8.1	7.1	5.9	4.9	4.3
38								8.4	8.0	7.8	7.5	6.7	5.4	4.7	3.9
40									7.4	7.1	6.8	6.2	5.1	4.4	3.6
42										6.8	6.5	6.2	5.7	4.8	4.0
44											6.0	5.6	5.4	4.6	3.9
46												5.1	5.0	4.3	3.5
48													4.6	4.1	3.4
50														4.3	3.2
52															3.7
54															3.0
配重 Counterweight (t)	65+20														

# 变幅副臂工况载荷表

## Luffing jib lifting load chart

主臂角 Boom angle	85°							
主臂 Boom (m)	58							
副臂 Jib (m)	20	23	26	29	32	35	38	41
幅度 Radius (m)								
14	21.9	21.9						
16	20.0	20.0	20.0	20.0	20.0			
18	17.5	17.5	17.5	17.5	17.5	17.5	17.5	
20	16.1	16.1	16.1	16.1	16.1	16.1	16.1	16.1
22	14.9	14.9	14.9	14.9	14.9	14.9	14.9	14.9
24	13.7	13.7	13.7	13.7	13.7	13.7	13.7	13.7
26		12.9	12.9	12.9	12.9	12.9	12.9	12.9
28			12.1	12.1	12.1	12.1	12.1	12.1
30				11.2	11.2	11.2	11.2	11.2
32				10.5	10.5	10.5	10.5	10.5
34					9.9	9.9	9.8	9.6
36						8.8	8.8	8.8
38							7.9	7.9
40							7.5	7.4
42								6.7

### 工作条件及注意

■ 本起重机的工作条件为：臂长 ≤ 50m 时风速小于 13.8m/s，臂长 > 50m 时风速小于 8.3m/s，环境温度 -20°C ~ +40°C，地面倾斜度小于 1%。

■ 载荷表中的额定起重量，是指在满足给定的工作条件下，重物自由悬挂，在坚实地面缓慢起吊重物，起重机不行走时的最大起重量。作业者须视各种不良条件（如地面松软或不平、风力、侧面负荷、摆动作用、多台起重机合力起吊等）限制或降低起重机的起重量。

■ 载荷表中额定起重量包括主吊钩、钢丝绳、和其它所有吊具的重量，安装臂端单滑轮时，还包括臂端单滑轮机构、13.5t 副钩及钢丝绳重量。各吊钩及臂端单滑轮的重量见下表：

160t 吊钩	100t 吊钩	32t 吊钩	13.5t 吊钩	臂端单滑轮
2.175 吨	1.665 吨	0.7 吨	0.5 吨	0.4 吨

■ 载荷表中没有列出额定载荷值的空白区为非工作区，起重机不允许在该区域内进行起重作业；

■ 表中起重量为带上车全配重和下车全配重的起重量；

■ 臂端单滑轮机构工作时，最大起重量按臂端单滑轮载荷表，注意应减去副钩 (0.5t)、钢丝绳及吊具的重量，但不需要减去主钩及钢丝绳的重量，也不必减去臂端单滑轮的重量。

■ 本机允许带载低速行驶，最大带载量为载荷表中额定载荷的 90%，如需转弯行驶，最大带载量为载荷表中额定载荷的 70%。

■ 吊钩及倍率的选取

在任何情况下，吊钩的选取必须满足吊钩的额定起重量大于或等于实际吊重量（包括钢丝绳及吊具等）。

### Working conditions and Cautions

■ The crane working conditions: boom length ≤ 50m when wind speed is less than 13.8m/s; boom length > 50m when wind speed is less than 8.3m/s; the ambient temperature is -20°C ~ +40°C; and the ground gradient is less than 1%.

■ The rated lifting load in the chart are the maximum lifting capacity on the condition that the given working conditions are met and the load is in the state of free suspension and lifted slowly from the solid ground. Operators should limit or reduce lifting capacity according to different conditions (such as soft or uneven ground, wind force, side loading, oscillating action, several crane cooperate-lifting).

■ The rated lifting capacity in the chart includes the weight of main hook block, wire rope and all slings. When single top is attached on boom head, the rated lifting capacity also includes the weight of boom single top, 13.5t capacity auxiliary hook block and wire rope.

160t hook block	100t hook block	32t hook block	13.5t hook block	Boom single top
2.175ton	1.665ton	0.7ton	0.5ton	0.4ton

■ The blank area of the chart where no rated lifting load listed is regarded as non-operation area, so crawler crane is not allowed to carry out lifting operation in this area.

■ The lifting load in the chart includes the lifting capacity of full counterweight on both crane superstructure and crane undercarriage.

■ When boom single top works, its maximum lifting capacity is according to the boom single top lifting load chart, and it is necessary to reduce the weight of auxiliary hook (0.5t), wire rope and slings, but it is not necessary to reduce the weight of main hook block and wire rope as well as the weight of boom single top.

■ This crawler crane is allowed to travel slowly with a suspended load, the maximum load weight is 90% of rated lifting load given in the load chart, but the maximum load weight is 70% of rated lifting load given in the load chart for the crane turning around.

■ Selection of hook block and parts of line

In any case, the selection of hook block must satisfy that the hook block rated lifting load is more than or equal to the actual lifting load (including wire rope, slings and etc.).